

ESD11A3.3DT5G SERIES

Transient Voltage Suppressors

ESD Protection Diodes in Ultra Small SOT-1123 Package

The ESD11A Series is designed to protect voltage sensitive components from damage due to ESD. These parts provide excellent ESD clamping capability and fast response time to enhance the immunity of the end application from system level ESD stress such as IEC61000-4-2. Two uni-directional TVS diodes are housed in the ultra small SOT-1123 package, making these parts ideal for ESD protection on designs where board space is at a premium, such as cell phones, MP3 players and many other portable handheld electronic devices.

Specification Features:

- Low Clamping Voltage
- Small Body Outline Dimensions:
0.039" x 0.024" (1.0 mm x 0.6 mm)
- Low Body Height: 0.016" (0.4 mm)
- Stand-off Voltage: 3.3 V – 5 V
- Low Leakage
- Response Time is Typically < 1 ns
- IEC61000-4-2 Level 4 ESD Protection
- These are Pb-Free Devices

Mechanical Characteristics:

CASE: Void-free, transfer-molded, thermosetting plastic
Epoxy Meets UL 94 V-0

LEAD FINISH: 100% Matte Sn (Tin)

MOUNTING POSITION: Any

QUALIFIED MAX REFLOW TEMPERATURE: 260°C

Device Meets MSL 1 Requirements

MAXIMUM RATINGS

Rating	Symbol	Value	Unit
IEC 61000-4-2 (ESD) Contact		±15	kV
Total Power Dissipation on FR-5 Board (Note 1) @ T _A = 25°C	P _D	150	mW
Storage Temperature Range	T _{stg}	-55 to +150	°C
Junction Temperature Range	T _J	-55 to +125	°C
Lead Solder Temperature – Maximum (10 Second Duration)	T _L	260	°C

Stresses exceeding Maximum Ratings may damage the device. Maximum Ratings are stress ratings only. Functional operation above the Recommended Operating Conditions is not implied. Extended exposure to stresses above the Recommended Operating Conditions may affect device reliability.

1. FR-5 = 1.0 x 0.75 x 0.62 in.



ON Semiconductor®

<http://onsemi.com>

PIN 1. CATHODE
2. CATHODE
3. ANODE

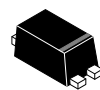
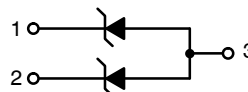

SOT-1123
CASE 524AA

MARKING DIAGRAM

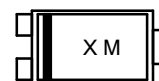

X = Specific Device Code
M = Date Code

ORDERING INFORMATION

Device	Package	Shipping†
ESD11AxxDT5G	SOT-1123 (Pb-Free)	8000/Tape & Reel

†For information on tape and reel specifications, including part orientation and tape sizes, please refer to our Tape and Reel Packaging Specifications Brochure, BRD8011/D.

DEVICE MARKING INFORMATION

See specific marking information in the device marking column of the table on page 2 of this data sheet.

See Application Note AND8308/D for further description of ESD maximum ratings.

ESD11A3.3DT5G SERIES

ELECTRICAL CHARACTERISTICS

($T_A = 25^\circ\text{C}$ unless otherwise noted)

Symbol	Parameter
I_{PP}	Maximum Reverse Peak Pulse Current
V_C	Clamping Voltage @ I_{PP}
V_{RWM}	Working Peak Reverse Voltage
I_R	Maximum Reverse Leakage Current @ V_{RWM}
V_{BR}	Breakdown Voltage @ I_T
I_T	Test Current
I_F	Forward Current
V_F	Forward Voltage @ I_F
P_{pk}	Peak Power Dissipation
C	Capacitance @ $V_R = 0$ and $f = 1$ MHz

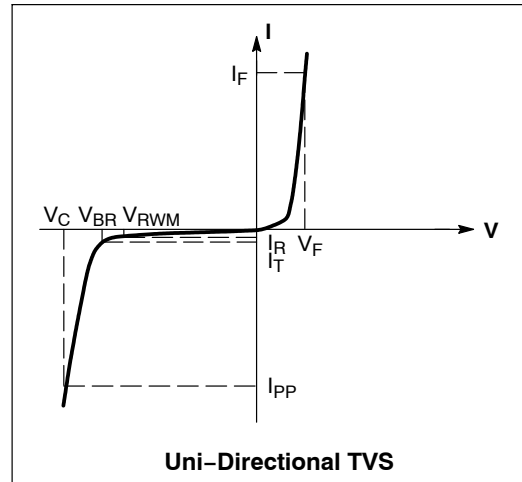

ELECTRICAL CHARACTERISTICS ($T_A = 25^\circ\text{C}$ unless otherwise noted, $V_F = 0.9$ V Max. @ $I_F = 10$ mA for all types)

Device	Device Marking	V_{RWM} (V)	I_R (μA) @ V_{RWM}	V_{BR} (V) @ I_T (Note 2)	I_T (mA)	C (pF), uni-directional (Note 3)		V_C (V) @ $I_{PP} = 1$ A (Note 5)	V_C (V) IEC61000-4-2 (Note 6)
		Max	Max	Min		Typ	Max	Max	Typ
ESD11A3.3DT5G	2*	3.3	1.0	5.2	1.0	25	35	7.8	Figures 1 thru 4
ESD11A5.0DT5G	3*	5.0	0.1	6.2	1.0	20	30	9.5	Figures 1 thru 4

*Rotated 90° clockwise.

- V_{BR} is measured with a pulse test current I_T at an ambient temperature of 25°C .
- Uni-directional capacitance at $f = 1$ MHz, $V_R = 0$ V, $T_A = 25^\circ\text{C}$ (pin1 to pin 3; pin 2 to pin 3).
- Bi-directional capacitance at $f = 1$ MHz, $V_R = 0$ V, $T_A = 25^\circ\text{C}$ (pin1 to pin 2).
- Surge current waveform per Figure 7.
- Typical waveform. For test procedure see Figures 5 and 6 and Application Note AND8307/D.

ESD11A3.3DT5G SERIES

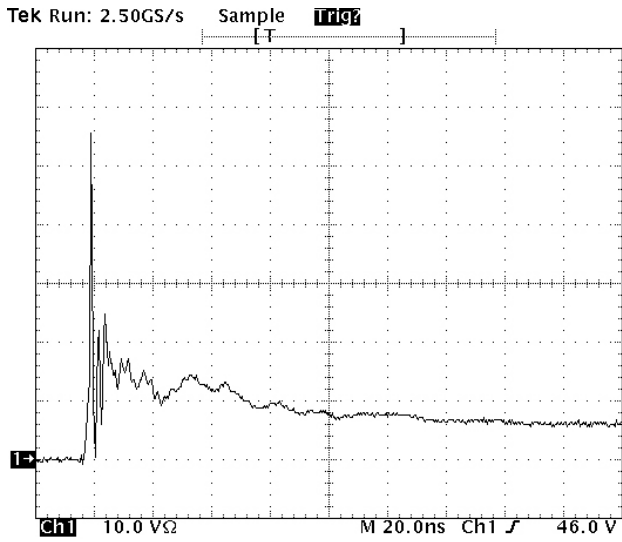

Figure 1. ESD11A3.3D Clamping Voltage Screenshot Positive 8 kV contact per IEC 61000-4-2

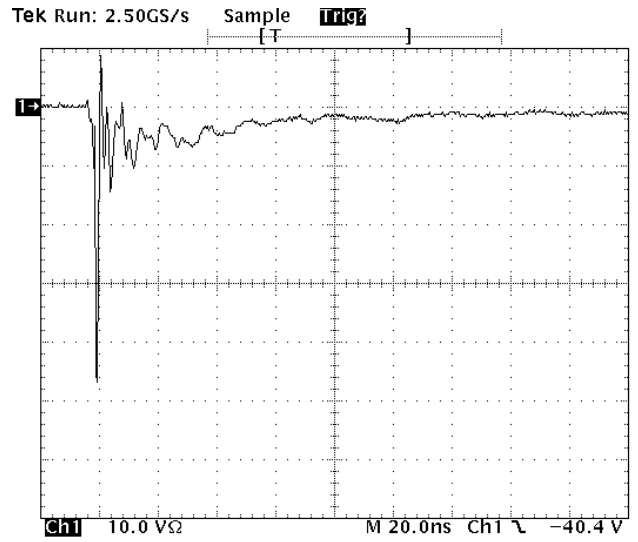

Figure 2. ESD11A3.3D Clamping Voltage Screenshot Negative 8 kV contact per IEC 61000-4-2

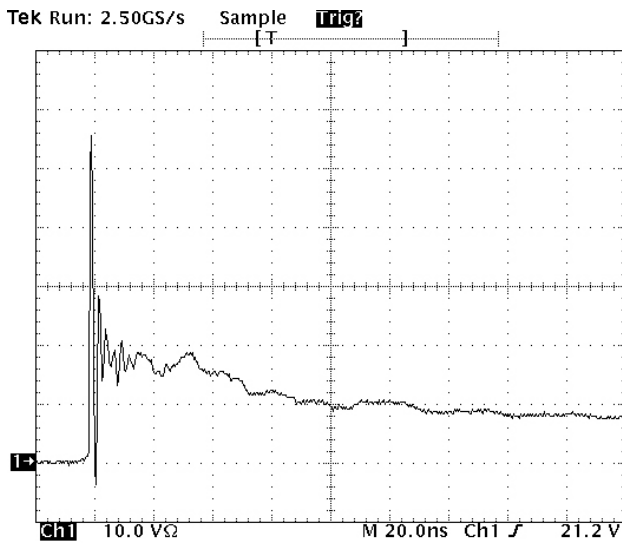

Figure 3. ESD11A5.0D Clamping Voltage Screenshot Positive 8 kV contact per IEC 61000-4-2

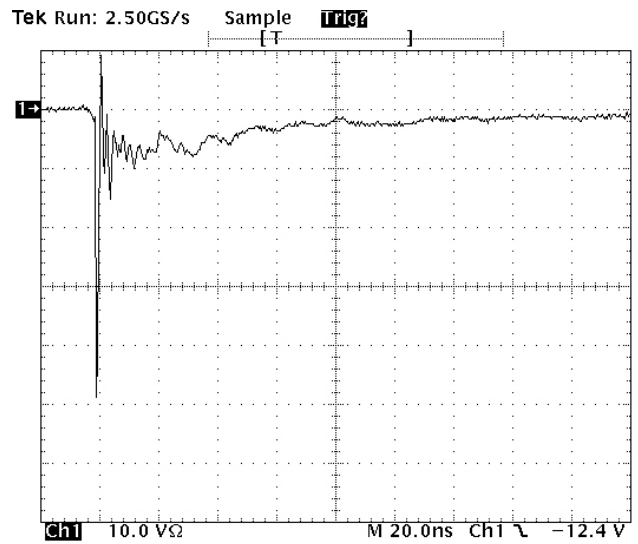

Figure 4. ESD11A5.0D Clamping Voltage Screenshot Negative 8 kV contact per IEC 61000-4-2

ESD11A3.3DT5G SERIES

IEC 61000-4-2 Spec.

Level	Test Voltage (kV)	First Peak Current (A)	Current at 30 ns (A)	Current at 60 ns (A)
1	2	7.5	4	2
2	4	15	8	4
3	6	22.5	12	6
4	8	30	16	8

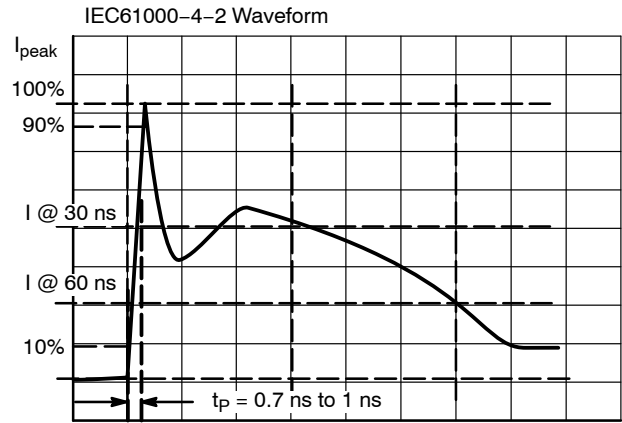

Figure 5. IEC61000-4-2 Spec

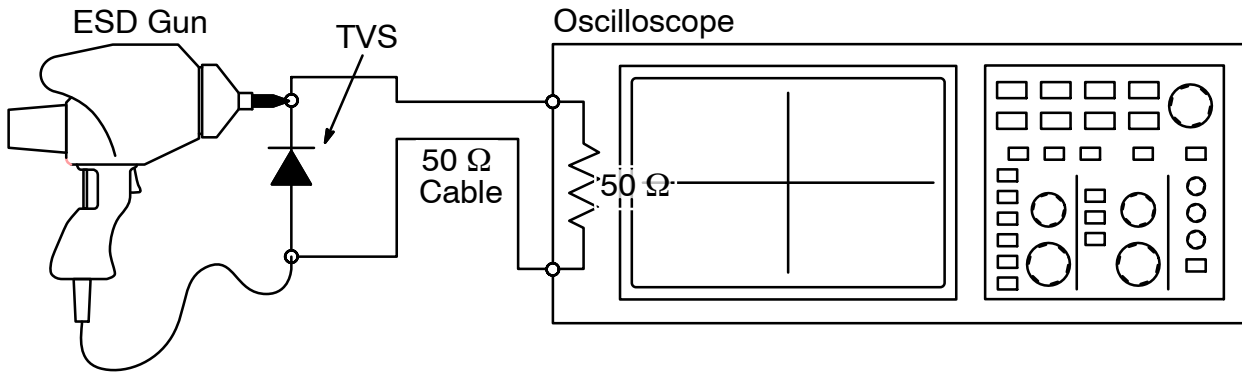

Figure 6. Diagram of ESD Test Setup

The following is taken from Application Note AND8308/D – Interpretation of Datasheet Parameters for ESD Devices.

ESD Voltage Clamping

For sensitive circuit elements it is important to limit the voltage that an IC will be exposed to during an ESD event to as low a voltage as possible. The ESD clamping voltage is the voltage drop across the ESD protection diode during an ESD event per the IEC61000-4-2 waveform. Since the IEC61000-4-2 was written as a pass/fail spec for larger

systems such as cell phones or laptop computers it is not clearly defined in the spec how to specify a clamping voltage at the device level. ON Semiconductor has developed a way to examine the entire voltage waveform across the ESD protection diode over the time domain of an ESD pulse in the form of an oscilloscope screenshot, which can be found on the datasheets for all ESD protection diodes. For more information on how ON Semiconductor creates these screenshots and how to interpret them please refer to AND8307/D.

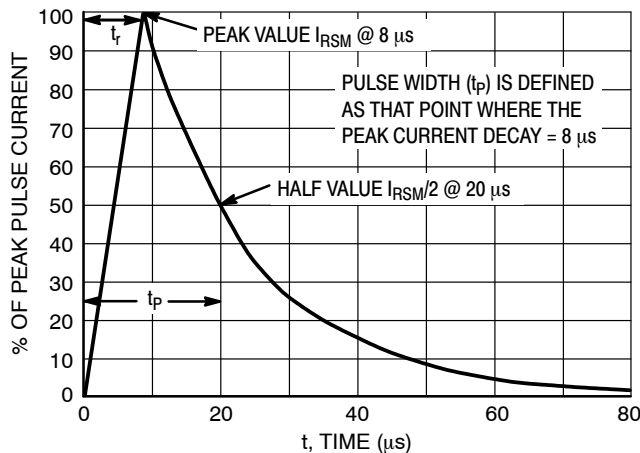
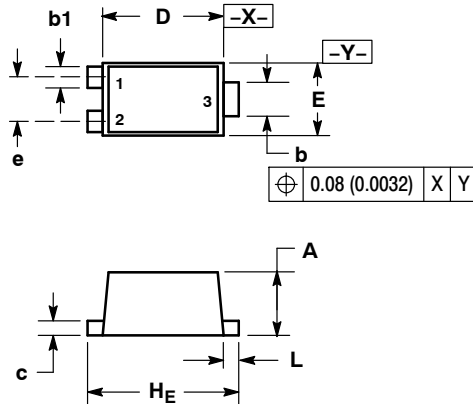

Figure 7. 8 X 20 μs Pulse Waveform

ESD11A3.3DT5G SERIES

PACKAGE DIMENSIONS

SOT-1123
CASE 524AA-01
ISSUE B



NOTES:

1. DIMENSIONING AND TOLERANCING PER ANSI Y14.5M, 1982.
2. CONTROLLING DIMENSION: MILLIMETERS.
3. MAXIMUM LEAD THICKNESS INCLUDES LEAD FINISH THICKNESS. MINIMUM LEAD THICKNESS IS THE MINIMUM THICKNESS OF BASE MATERIAL.

DIM	MILLIMETERS			INCHES		
	MIN	NOM	MAX	MIN	NOM	MAX
A	0.34	0.37	0.40	0.013	0.015	0.016
b	0.15	0.22	0.28	0.006	0.009	0.011
b1	0.10	0.15	0.20	0.004	0.006	0.008
c	0.07	0.12	0.17	0.003	0.005	0.007
D	0.75	0.80	0.85	0.030	0.031	0.033
E	0.55	0.60	0.65	0.022	0.024	0.026
e	0.35	---	0.40	0.014	----	0.016
HE	0.95	1.00	1.05	0.037	0.039	0.041
L	0.05	0.10	0.15	0.002	0.004	0.006

SOLDERING FOOTPRINT*

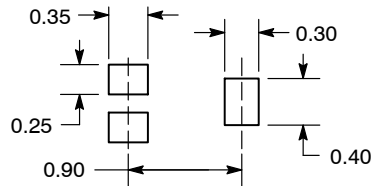

DIMENSIONS: MILLIMETERS

*For additional information on our Pb-Free strategy and soldering details, please download the ON Semiconductor Soldering and Mounting Techniques Reference Manual, SOLDERRM/D.

ON Semiconductor and are registered trademarks of Semiconductor Components Industries, LLC (SCILLC). SCILLC reserves the right to make changes without further notice to any products herein. SCILLC makes no warranty, representation or guarantee regarding the suitability of its products for any particular purpose, nor does SCILLC assume any liability arising out of the application or use of any product or circuit, and specifically disclaims any and all liability, including without limitation special, consequential or incidental damages. "Typical" parameters which may be provided in SCILLC data sheets and/or specifications can and do vary in different applications and actual performance may vary over time. All operating parameters, including "Typicals" must be validated for each customer application by customer's technical experts. SCILLC does not convey any license under its patent rights nor the rights of others. SCILLC products are not designed, intended, or authorized for use as components in systems intended for surgical implant into the body, or other applications intended to support or sustain life, or for any other application in which the failure of the SCILLC product could create a situation where personal injury or death may occur. Should Buyer purchase or use SCILLC products for any such unintended or unauthorized application, Buyer shall indemnify and hold SCILLC and its officers, employees, subsidiaries, affiliates, and distributors harmless against all claims, costs, damages, and expenses, and reasonable attorney fees arising out of, directly or indirectly, any claim of personal injury or death associated with such unintended or unauthorized use, even if such claim alleges that SCILLC was negligent regarding the design or manufacture of the part. SCILLC is an Equal Opportunity/Affirmative Action Employer. This literature is subject to all applicable copyright laws and is not for resale in any manner.

PUBLICATION ORDERING INFORMATION

LITERATURE FULFILLMENT:
Literature Distribution Center for ON Semiconductor
P.O. Box 5163, Denver, Colorado 80217 USA
Phone: 303-675-2175 or 800-344-3860 Toll Free USA/Canada
Fax: 303-675-2176 or 800-344-3867 Toll Free USA/Canada
Email: orderlit@onsemi.com

N. American Technical Support: 800-282-9855 Toll Free
USA/Canada
Europe, Middle East and Africa Technical Support:
Phone: 421 33 790 2910
Japan Customer Focus Center
Phone: 81-3-5773-3850

ON Semiconductor Website: www.onsemi.com
Order Literature: <http://www.onsemi.com/orderlit>
For additional information, please contact your local Sales Representative